

From Einstein's doubts to quantum information: the second quantum revolution

IEEE ICC 2017

Paris, 23/05/2017



Alain Aspect – Institut d'Optique Graduate School – Palaiseau

<http://www.lcf.institutoptique.fr/Alain-Aspect-homepage>

mooc: <https://www.coursera.org/learn/quantum-optics-single-photon>

From Einstein's doubts to quantum information: a new quantum revolution

1. Quantum information: how did it emerge?
2. From the Einstein-Bohr debate to Bell's inequalities tests: **entanglement**
3. A new quantum revolution? Conceptual and technological

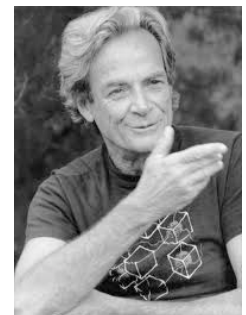
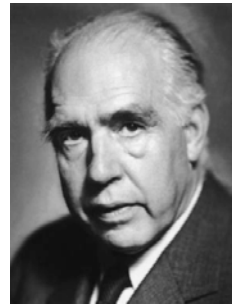

Quantum information a flourishing field

Google

quantum information

[Quantum Information](#)

www.vjquantuminfo.org/ - Traduire cette page

Virtual Journal of **Quantum Information**, a multijournal compilation, contains articles that focus on **quantum information**, including quantum computing, ...

[The Possibilities of Quantum Information - NYTimes.com](#)

www.nytimes.com/.../the-possibilities-of-quantum... - Traduire cette page

13 oct. 2012 – **Quantum information** theory could well usher in a radical new era of technology, one that makes today's fastest computers look like ...

[Institute for Quantum Information](#)

www.iqi.caltech.edu/ - Traduire cette page

CalTech's Institute provides lectures and papers for intermediate and advanced readers on the subject of **Quantum Information** and Quantum Computing.

[quantum information science @ mit](#)

qis.mit.edu/ - Traduire cette page

Learn about **quantum information** by enrolling in one of MIT's courses (both graduate and undergraduate). Use our e-print and journal search interface on to ...

[Centre for Quantum Information and Foundations: Homepage](#)

www.qi.damtp.cam.ac.uk/ - Traduire cette page

The Centre for **Quantum Information** and Foundations (formerly the Centre for Quantum Computation), part of the University of Cambridge, and based within the ...

Quantum information: how did it emerge?

MAY 15, 1935

PHYSICAL REVIEW

VOLUME 47

Can Quantum-Mechanical Description of Physical Reality Be Considered Complete?

A. EINSTEIN, B. PODOLSKY AND N. ROSEN, *Institute for Advanced Study, Princeton, New Jersey*
(Received March 25, 1935)

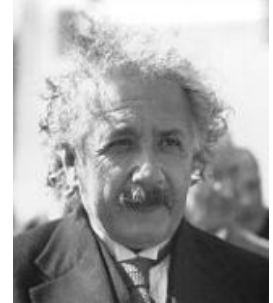

OCTOBER 15, 1935

PHYSICAL REVIEW

VOLUME 48

Can Quantum-Mechanical Description of Physical Reality be Considered Complete?

N. BOHR, *Institute for Theoretical Physics, University, Copenhagen*
(Received July 13, 1935)



Proceedings of the Cambridge Philosophical Society, 1935 - hep.princeton.edu

DISCUSSION OF PROBABILITY RELATIONS BETWEEN SEPARATED SYSTEMS

By E. SCHRÖDINGER

[Communicated by Mr M. BORN]



Entanglement
is different!

Physics Vol. 1, No. 3, pp. 195-200, 1964 Physics Publishing Co. Printed in the United States

ON THE EINSTEIN-PODOLSKY-ROSEN PARADOX*

J. S. BELL[†]

Department of Physics, University of Wisconsin, Madison, Wisconsin

[†]On leave of absence from SLAC and CERN

Quantum information: how did it emerge?

International Journal of Theoretical Physics, Vol. 21, Nos. 6/7, 1982

Simulating Physics with Computers

Richard P. Feynman

Department of Physics, California Institute of Technology, Pasadena, California 91107

Entanglement
is more!



From Einstein's doubts to quantum information: a new quantum revolution

1. Quantum technologies: how did it emerge?
2. From the Einstein-Bohr debate to Bell's inequalities tests: **entanglement**
3. A new quantum revolution? Conceptual and technological

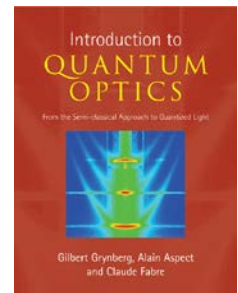
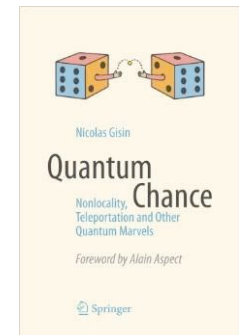
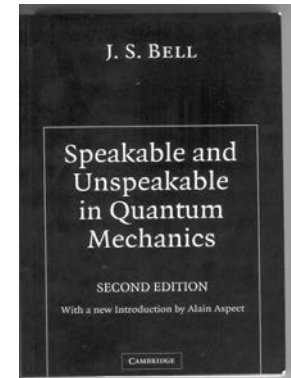

Einstein and quantum physics

A founding contribution (1905)

Light is made of quanta, later named photons, which have well defined energy and momentum. **Nobel 1922.**

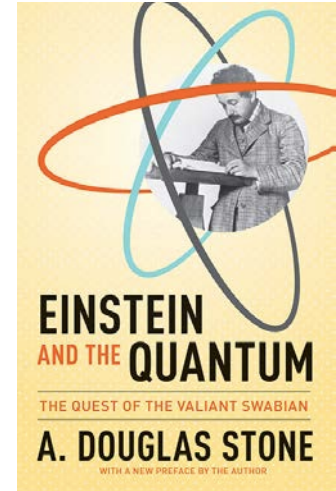

A fruitful objection (1935): entanglement

Einstein, Podolsky, Rosen (EPR): The quantum formalism allows one to envisage amazing situations (**pairs of entangled particles**): **the formalism must be completed.**

Objection underestimated for a long time (except Bohr's answer and Schrödinger comment, 1935) until **Bell's theorem (1964)** and the acknowledgement of its importance (1970-82).

Entanglement at the core of quantum information (198x-20??)

The EPR question

Is it possible (necessary) to explain the probabilistic character of quantum predictions by invoking a supplementary underlying level of description (supplementary parameters, hidden variables) ?

A positive answer was the conclusion of the Einstein-Podolsky-Rosen reasoning (1935). Bohr strongly opposed this conclusion.

Bell's theorem (1964) has allowed us to settle the debate.

The EPR GedankenExperiment with photons correlated in polarization

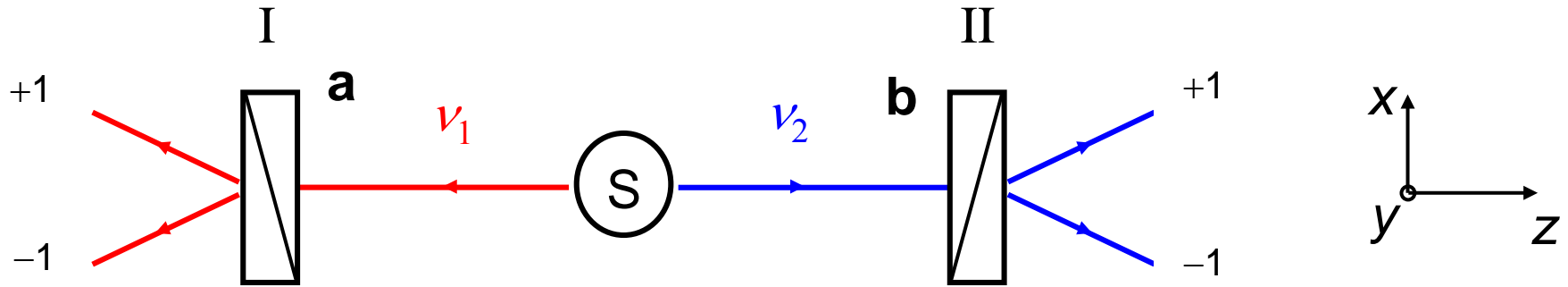

Measurement of the **polarization of v_1 along orientation \mathbf{a}** and **of polarization of v_2 along orientation \mathbf{b}** : results $+1$ or -1

- Probabilities to find $+1$ ou -1 for v_1 (measured along \mathbf{a}) and $+1$ or -1 for v_2 (measured along \mathbf{b}).

Single probabilities

$$P_+(\mathbf{a}), P_-(\mathbf{a})$$

$$P_+(\mathbf{b}), P_-(\mathbf{b})$$

Joint probabilities

$$P_{++}(\mathbf{a}, \mathbf{b}), P_{+-}(\mathbf{a}, \mathbf{b})$$

$$P_{-+}(\mathbf{a}, \mathbf{b}), P_{--}(\mathbf{a}, \mathbf{b})$$

The EPR GedankenExperiment with photons correlated in polarization

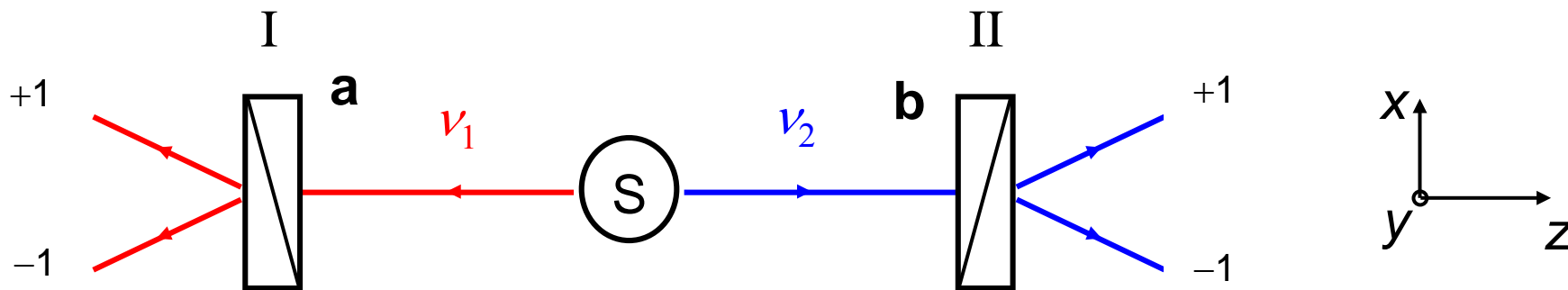

For the entangled EPR state... $|\Psi(v_1, v_2)\rangle = \frac{1}{\sqrt{2}} \{ |x, x\rangle + |y, y\rangle \}$

Quantum mechanics predicts
results separately random ...

$$P_+(\mathbf{a}) = P_-(\mathbf{a}) = \frac{1}{2} ; P_+(\mathbf{b}) = P_-(\mathbf{b}) = \frac{1}{2}$$

but
strongly
correlated:

$$P_{++}(\mathbf{a}, \mathbf{b}) = P_{--}(\mathbf{a}, \mathbf{b}) = \frac{1}{2} \cos^2(\mathbf{a}, \mathbf{b})$$

$$P_{+-}(\mathbf{a}, \mathbf{b}) = P_{-+}(\mathbf{a}, \mathbf{b}) = \frac{1}{2} \sin^2(\mathbf{a}, \mathbf{b})$$

$$P_{++}(0) = P_{--}(0) = \frac{1}{2}$$

$$P_{+-}(0) = P_{-+}(0) = 0$$

Coefficient of correlation of polarization (EPR state)

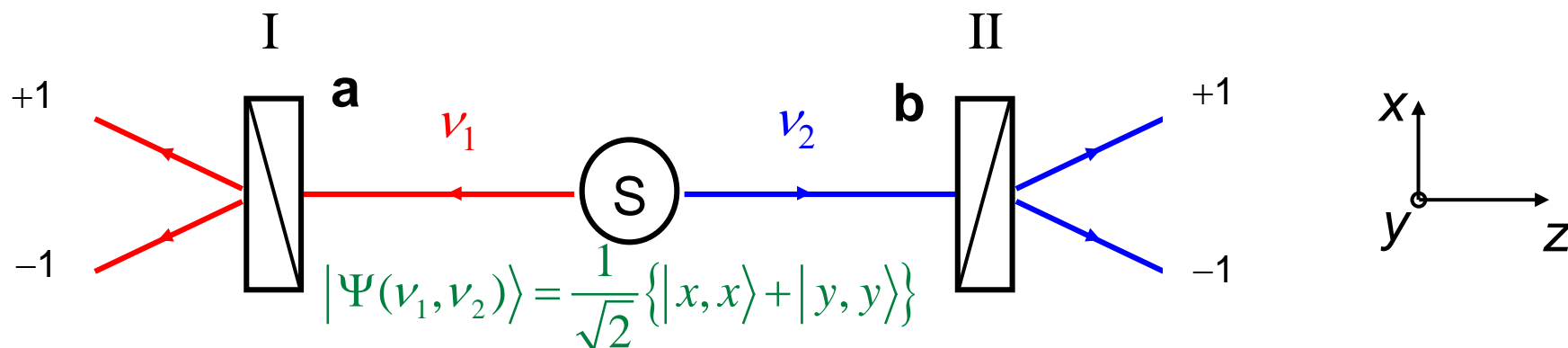

Quantitative expression of the **correlations** between results of measurements in I et II: **coefficient**:

$$E = P_{++} + P_{--} - P_{+-} - P_{-+} = P(\text{résultats id}^\circ) - P(\text{résultats } \neq)$$

<p>QM predicts, for parallel polarizers (a,b) = 0</p>	$P_{++} = P_{--} = \frac{1}{2}$ $P_{+-} = P_{-+} = 0$	$\Rightarrow E_{\text{MQ}} = 1$ Total correlation
---	--	---

More generally, for an arbitrary angle (a,b) between polarizers

$$E_{\text{MQ}}(\mathbf{a}, \mathbf{b}) = \cos 2(\mathbf{a}, \mathbf{b})$$

How to “understand” the EPR correlations predicted by quantum mechanics?

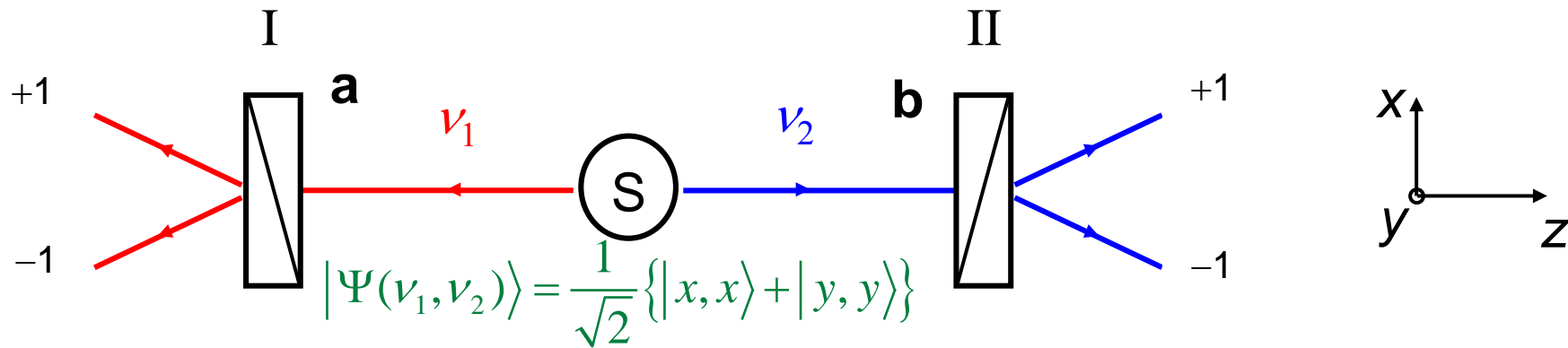

$$E_{\text{MQ}}(\mathbf{a}, \mathbf{b}) = \cos 2(\mathbf{a}, \mathbf{b})$$

Can we derive an image from the QM calculation?

How to “understand” the EPR correlations predicted by quantum mechanics?

Can we derive an image from the QM calculation?

The direct calculation $P_{++}(\mathbf{a}, \mathbf{b}) = |\langle +_{\mathbf{a}}, +_{\mathbf{b}} | \Psi(\nu_1, \nu_2) \rangle|^2 = \frac{1}{2} \cos^2(\mathbf{a}, \mathbf{b})$ is done in an abstract space, where the two particles are described globally: impossible to extract an image in real space where the two photons are separated.

Related to the non factorability of the entangled state:

$$|\Psi(\nu_1, \nu_2)\rangle = \frac{1}{\sqrt{2}} \{ |x, x\rangle + |y, y\rangle \} \neq |\phi(\nu_1)\rangle \cdot |\chi(\nu_2)\rangle$$

One cannot identify properties attached to each photon separately

“Quantum phenomena do not occur in a Hilbert space, they occur in a laboratory” (A. Peres) \Rightarrow An image in real space?

A real space image of the EPR correlations from a quantum calculation

2 steps calculation (standard QM): same results

1) Measure on v_1 by I (along x)

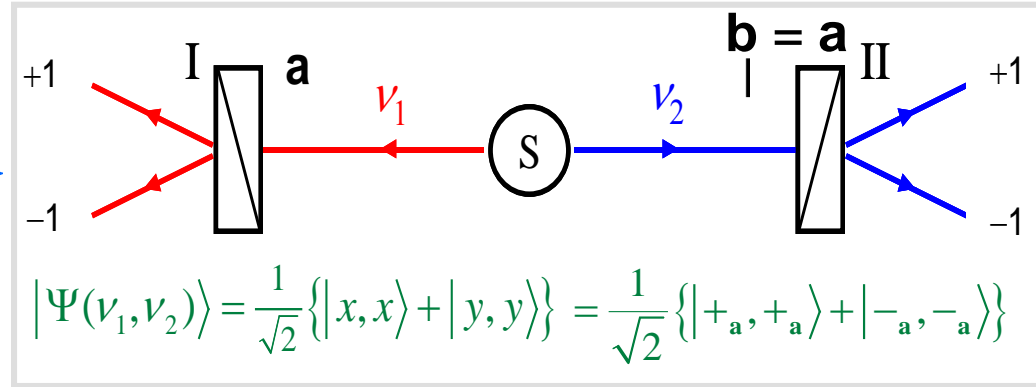

\Rightarrow result $+1$ $|x\rangle$
 or
 \Rightarrow result -1 $|y\rangle$

Just after the measure, “collapse of the state vector”: projection onto the eigenspace associated to the result

$|x, x\rangle$
 or
 $|y, y\rangle$

2) Measure on v_2 by II (along x)

- If one has found $+1$ for v_1 then the state of v_2 is $|x\rangle$ and the measurement along x yields $+1$;
- If one has found -1 for v_1 then the state of v_2 is $|y\rangle$ and the measurement along x yields -1 ;

Easily generalized to $b \neq a$ (Malus law)

The measurement on v_1 seems to influence instantaneously at a distance the state of v_2 : unacceptable for Einstein (relativistic causality).

A classical image for the correlations at a distance (suggested by the EPR reasoning)

- The two photons of the same pair bear from their very emission an identical property (λ), that will determine the results of polarization measurements.
- The property λ differs from one pair to another.

exemple

$\lambda = x, x$

or

$\lambda = y, y$

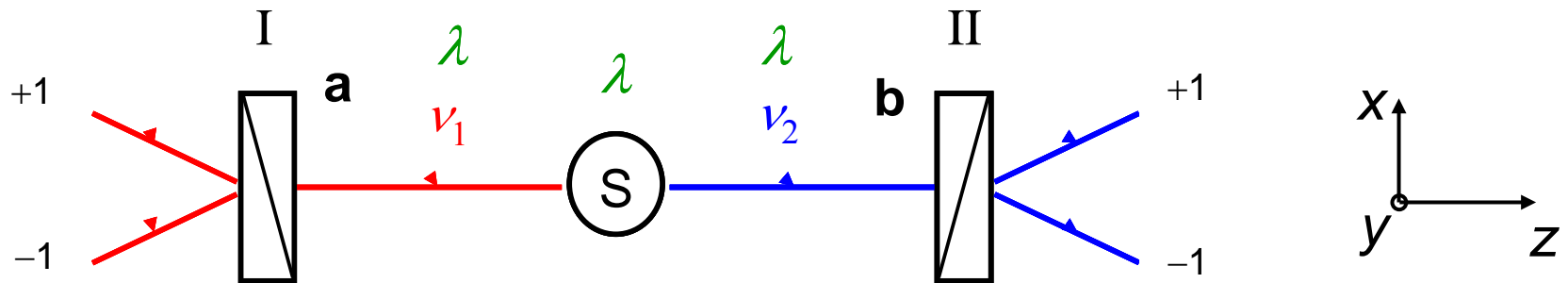

Image simple and convincing (analogue of identical chromosomes for twin brothers), but.....amounts to completing quantum formalism:
 $\lambda =$ supplementary parameter, “hidden variable”.

⇒ Bohr disagreed: QM description is complete, you cannot add anything to it

A debate for many decades

Intense debate between Bohr and Einstein...

... without much attention from a majority of physicists



- Quantum mechanics accumulates success:
 - Understanding nature: structure and properties of matter, light, and their interaction (atoms, molecules, absorption, spontaneous emission, solid properties, superconductivity, superfluidity, elementary particles ...)
 - New concepts leading to revolutionary inventions: transistor (later: laser, integrated circuits...)
- No disagreement on the validity of quantum predictions, only on its interpretation.

1964: Bell's formalism

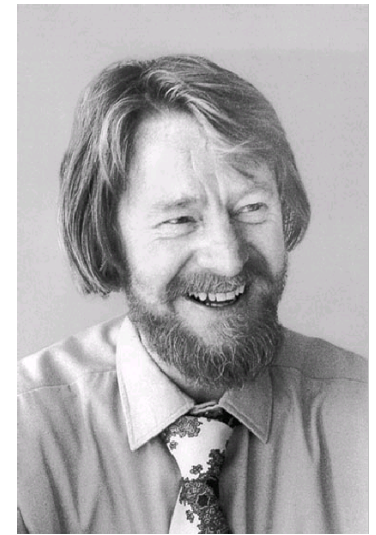
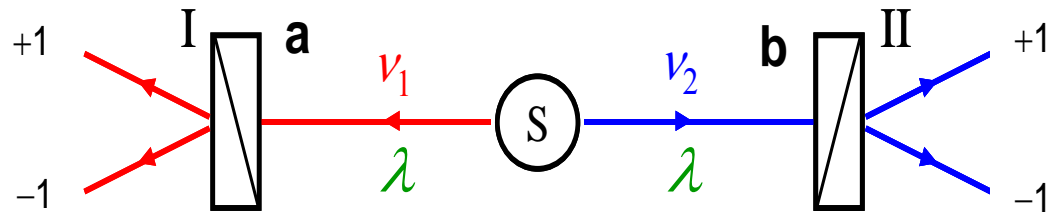

Consider **local supplementary parameters theories** (in the spirit of Einstein's ideas on EPR correlations):

- The two photons of a same pair have a common property λ (sup. param.) determined at the joint emission
- The supplementary parameter λ determines the results of measurements at I and II \Leftrightarrow

$$A(\lambda, \mathbf{a}) = +1 \text{ or } -1 \text{ at polarizer I}$$

$$B(\lambda, \mathbf{b}) = +1 \text{ or } -1 \text{ at polarizer II}$$
- The supplementary parameter λ is randomly distributed among pairs \Leftrightarrow

$$\rho(\lambda) \geq 0 \text{ and } \int \rho(\lambda) d\lambda = 1$$

at source S

$$E(\mathbf{a}, \mathbf{b}) = \int d\lambda \rho(\lambda) A(\lambda, \mathbf{a}) B(\lambda, \mathbf{b})$$

1964: Bell's formalism to explain correlations

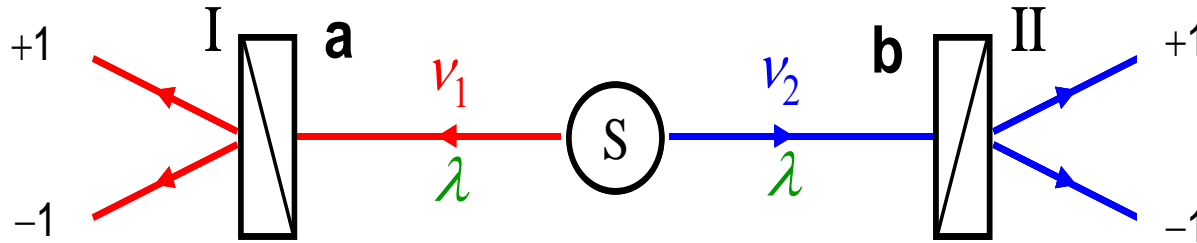

An example

- Common polarisation λ , randomly distributed among pairs $\rho(\lambda) = 1/2\pi$
- Result (± 1) depends on the angle between λ and polarizer orientation (\mathbf{a} or \mathbf{b})

$$A(\lambda, \mathbf{a}) = \text{sign} \{ \cos 2(\theta_{\mathbf{a}} - \lambda) \}$$

$$B(\lambda, \mathbf{b}) = \text{sign} \{ \cos 2(\theta_{\mathbf{b}} - \lambda) \}$$

Resulting correlation

Not bad, but no exact agreement

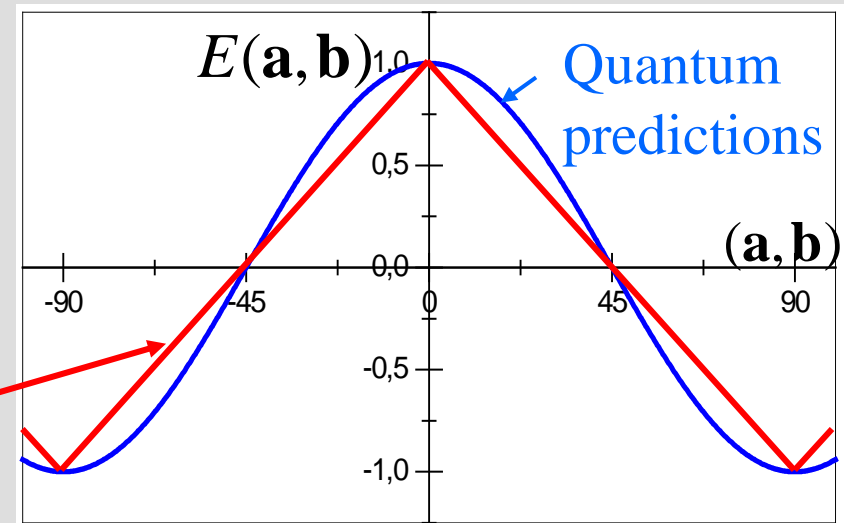

Is there a better model, agreeing with QM predictions at all orientations?

Bell's theorem gives the answer

Bell's theorem

No!

No **local hidden variable theory** (in the spirit of Einstein's ideas) can reproduce **quantum mechanical predictions** for EPR correlations at **all** the orientations of polarizers.

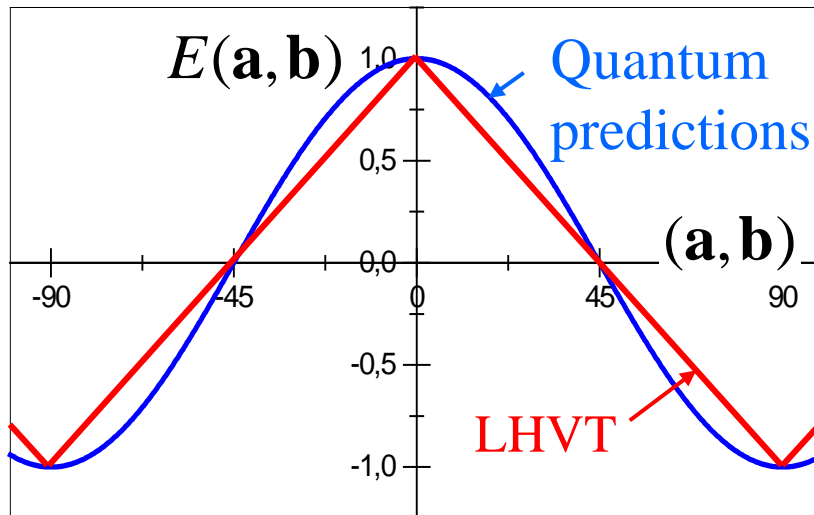
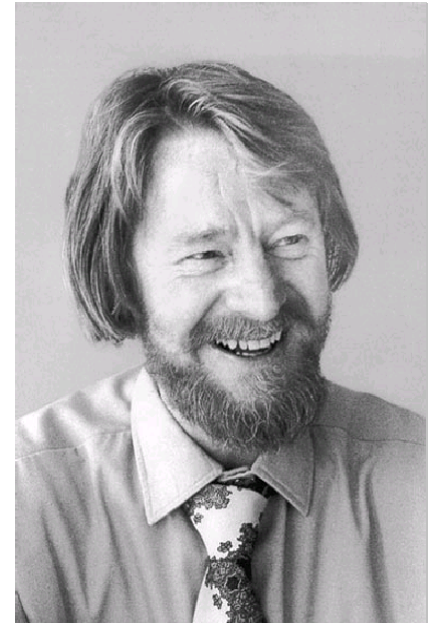

Impossible to cancel the difference everywhere

Impossible to have quantum predictions exactly reproduced at *all* orientations, by any model à la Einstein

Bell's inequalities are violated by certain quantum predictions

Any local hidden variables theory \Rightarrow Bell's inequalities

$$-2 \leq S \leq 2 \quad \text{avec} \quad S = E(\mathbf{a}, \mathbf{b}) - E(\mathbf{a}, \mathbf{b}') + E(\mathbf{a}', \mathbf{b}) + E(\mathbf{a}', \mathbf{b}')$$

CHSH inequ. (Clauser, Horne, Shimony, Holt, 1969)

Quantum mechanics $E_{\text{QM}}(\mathbf{a}, \mathbf{b}) = \cos 2(\mathbf{a}, \mathbf{b})$

For orientations $(\mathbf{a}, \mathbf{b}) = (\mathbf{b}, \mathbf{a}') = (\mathbf{a}', \mathbf{b}) = \frac{\pi}{8}$

$$S_{\text{QM}} = 2\sqrt{2} = 2.828... > 2$$

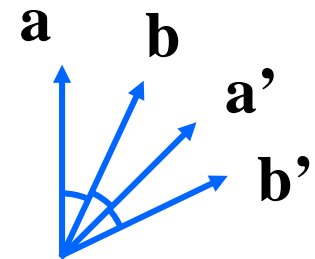

CONFLICT ! The possibility to complete quantum mechanics according to Einstein ideas is no longer a matter of taste (of interpretation). It has turned into an experimental question.

Conditions for a conflict

(\Rightarrow hypotheses for Bell's inequalities)

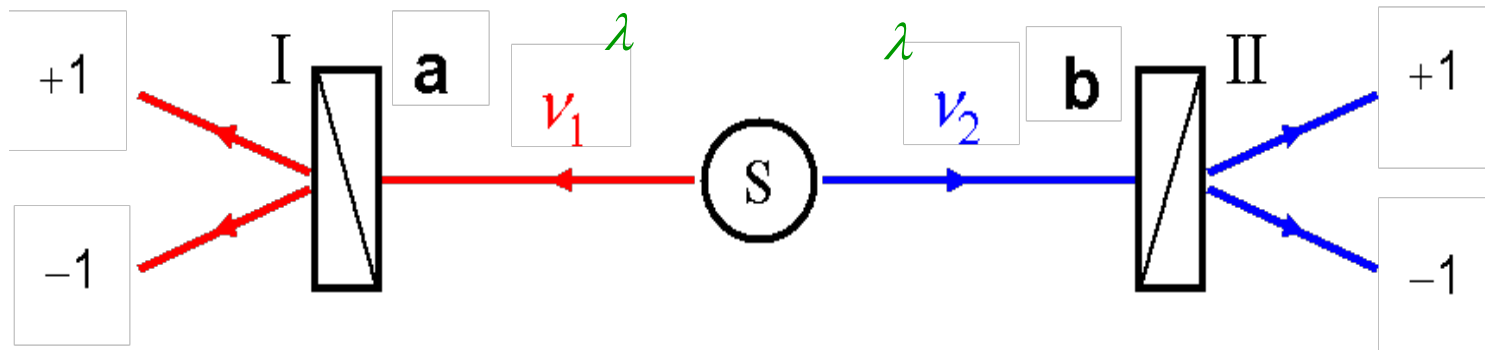

Supplementary parameters λ carried along by each particle.

Explanation of correlations « à la Einstein » attributing individual properties to each separated particle: **local realist world view**.

**Bell's
locality
condition**

- The result $A(\lambda, \mathbf{a})$ of the measurement on v_1 by I does not depend on the orientation \mathbf{b} of distant polarizer II (and conv.)
- The distribution $\rho(\lambda)$ of supplementary parameters over the pairs does not depend on the orientations \mathbf{a} and \mathbf{b} .

Bell's locality condition



$$A(\lambda, \mathbf{a}, \mathbf{b}) \quad B(\lambda, \mathbf{a}, \mathbf{b}) \quad \rho(\lambda, \mathbf{a}, \mathbf{b})$$

can be stated as a reasonable hypothesis, but...

...in an experiment with **variable polarizers** (orientations modified faster than the propagation time L/c of light between polarizers) Bell's locality condition becomes a consequence of **Einstein's relativistic causality** (no faster than light influence)
cf. Bohm & Aharonov, Physical Review, 1957

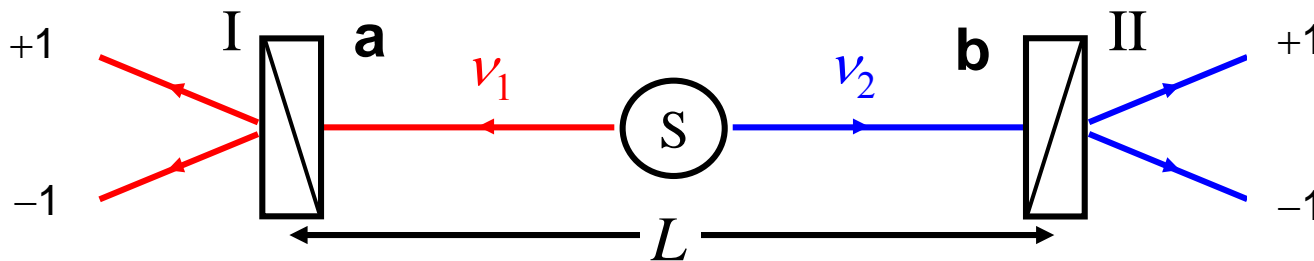

Conflict between **quantum mechanics** and **Einstein's world view** (local realism based on relativity).

From epistemology debates to experimental tests

Bell's theorem demonstrates a **quantitative incompatibility** between the **local realist world view (à la Einstein)** –which is constrained by Bell's inequalities, and **quantum predictions for pairs of entangled particles** –which violate Bell's inequalities.

An experimental test is possible.

When Bell's paper was written (1964), there was **no experimental result available to be tested against Bell's inequalities**:

- Bell's inequalities apply to **all correlations** that can be described within **classical physics** (mechanics, electrodynamics).
- **B I** apply to most of the situations which are described within quantum physics (**except EPR correlations**)

One must find a situation where the test is possible:
CHSH proposal (1969)

Three generations of experiments

Pioneers (1972-76): Berkeley, Harvard, Texas A&M

- First results contradictory (Clauser = QM; Pipkin \neq QM)
- Clear trend in favour of Quantum mechanics (Clauser, Fry)
- Experiments significantly different from the ideal scheme

Institut d'optique experiments (1975-82)

- A source of entangled photons of unprecedented efficiency
- Schemes closer and closer to the ideal GedankenExperiment
- Test of quantum non locality (relativistic separation)

Third generation experiments (1988-2015): Maryland, Rochester, Malvern, Genève, Innsbruck, Los Alamos, Boulder, Urbana Champaign, Vienna, Delft...

- New sources of entangled pairs
- Closure of the last loopholes
- Entanglement at very large distance
- Entanglement on demand

Orsay's source of pairs of entangled photons (1981)

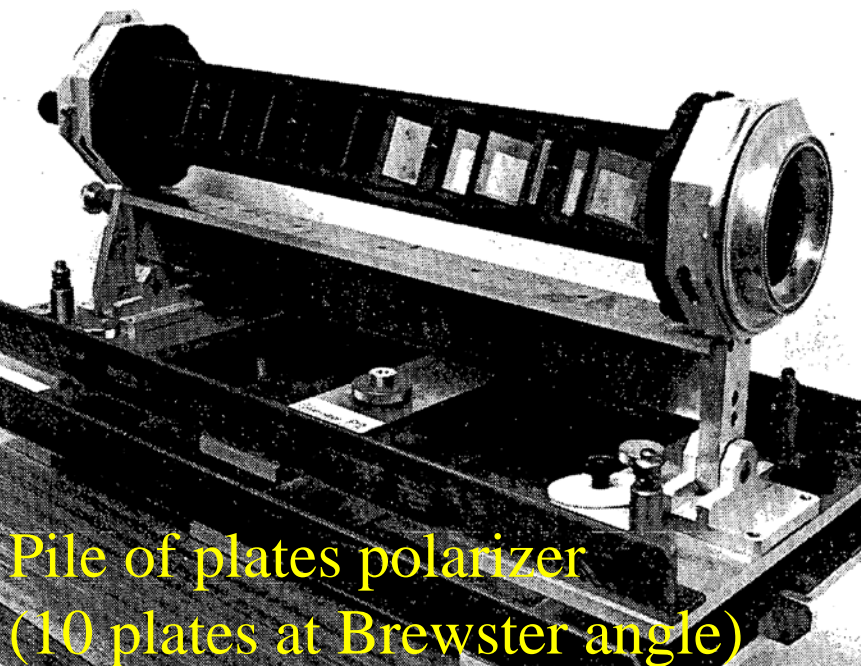
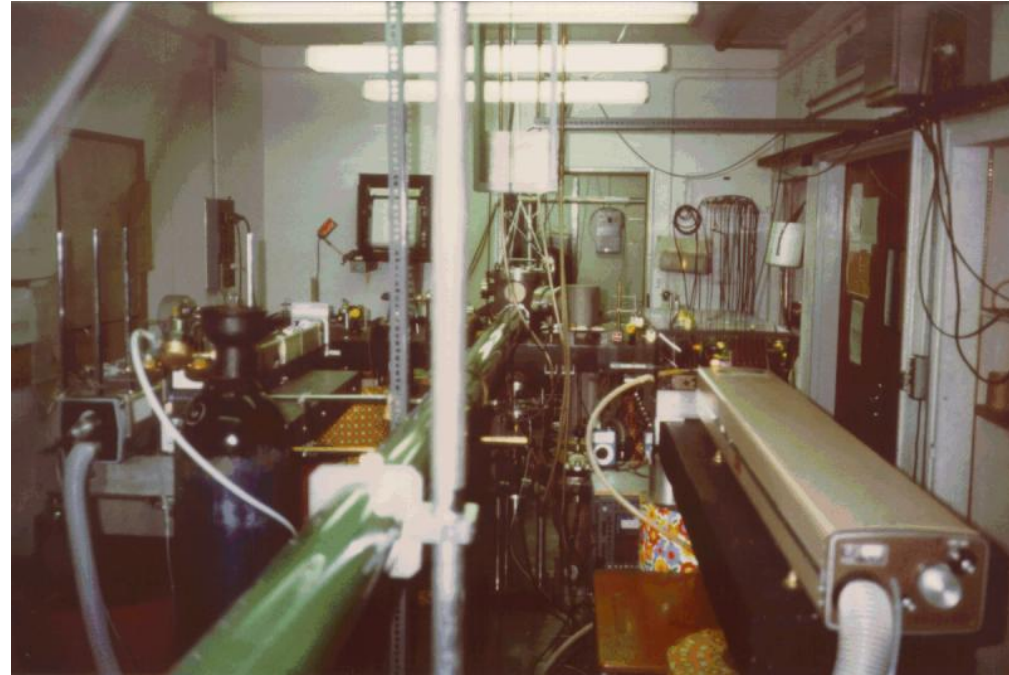
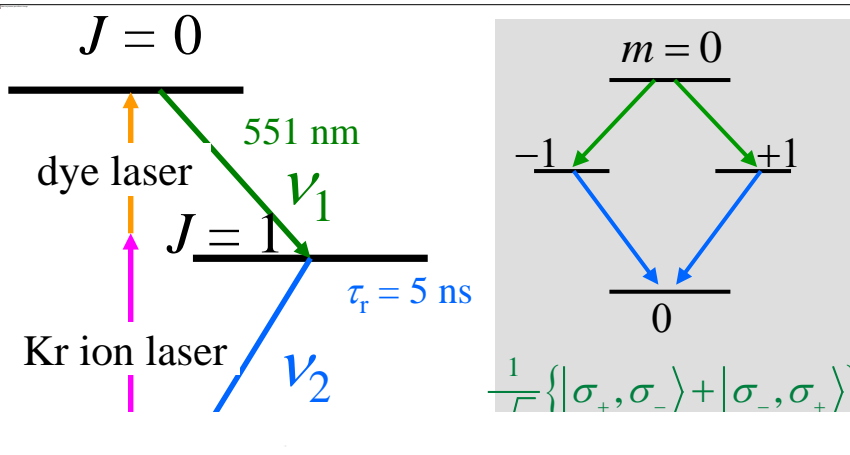

☺ 100 coincidences per second
 1% precision for 100 s counting
 Polarizers at 6 m from the source:
 violation of Bell's inequalities,
 entanglement survives
 macroscopic distance

Experiment with 2-channel polarizers (AA, P. Grangier, G. Roger, 1982)

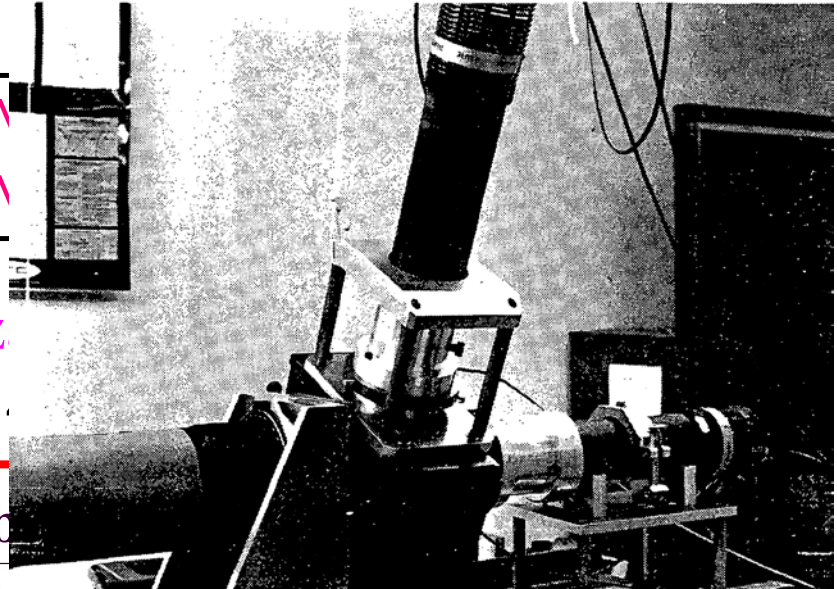
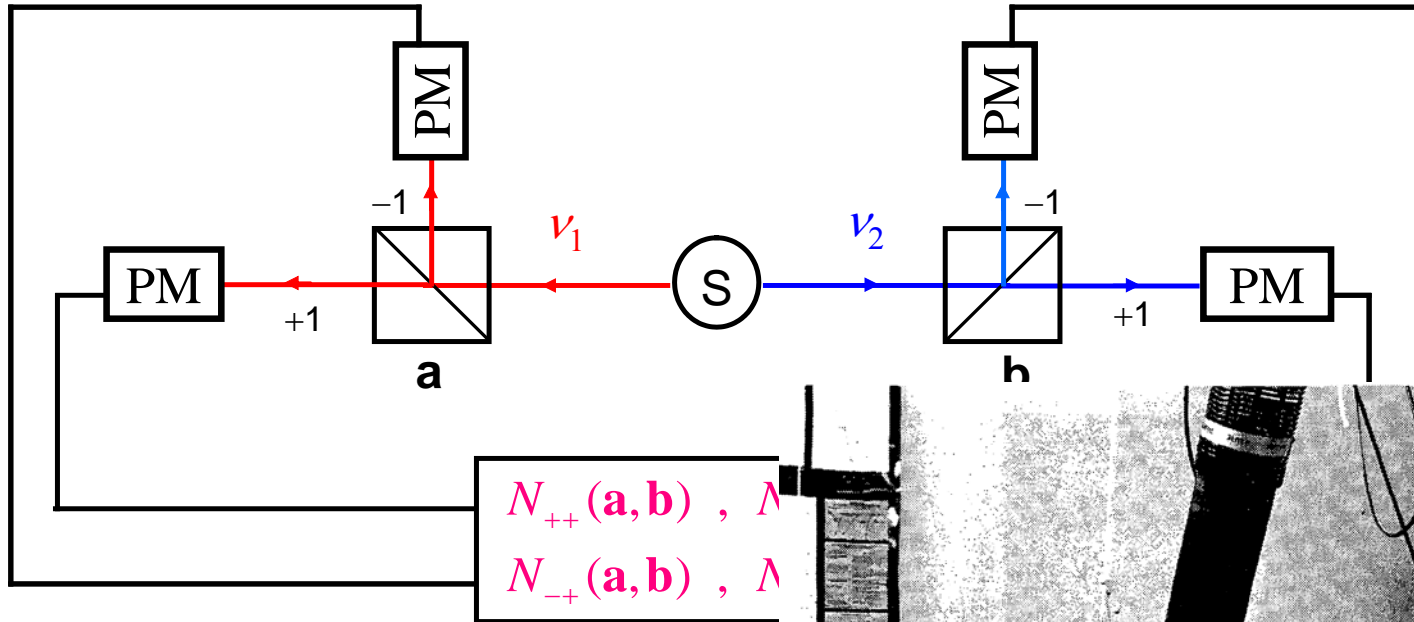

Direct measurement of the polariz
simultaneous measurement of the

$$E(\mathbf{a}, \mathbf{b}) = \frac{N_{++}(\mathbf{a}, \mathbf{b}) - N_{+-}(\mathbf{a}, \mathbf{b})}{N_{++}(\mathbf{a}, \mathbf{b}) + N_{+-}(\mathbf{a}, \mathbf{b}) + N_{-+}(\mathbf{a}, \mathbf{b}) + N_{--}(\mathbf{a}, \mathbf{b})}$$

Experiment with 2-channel polarizers (AA, P. Grangier, G. Roger, 1982)

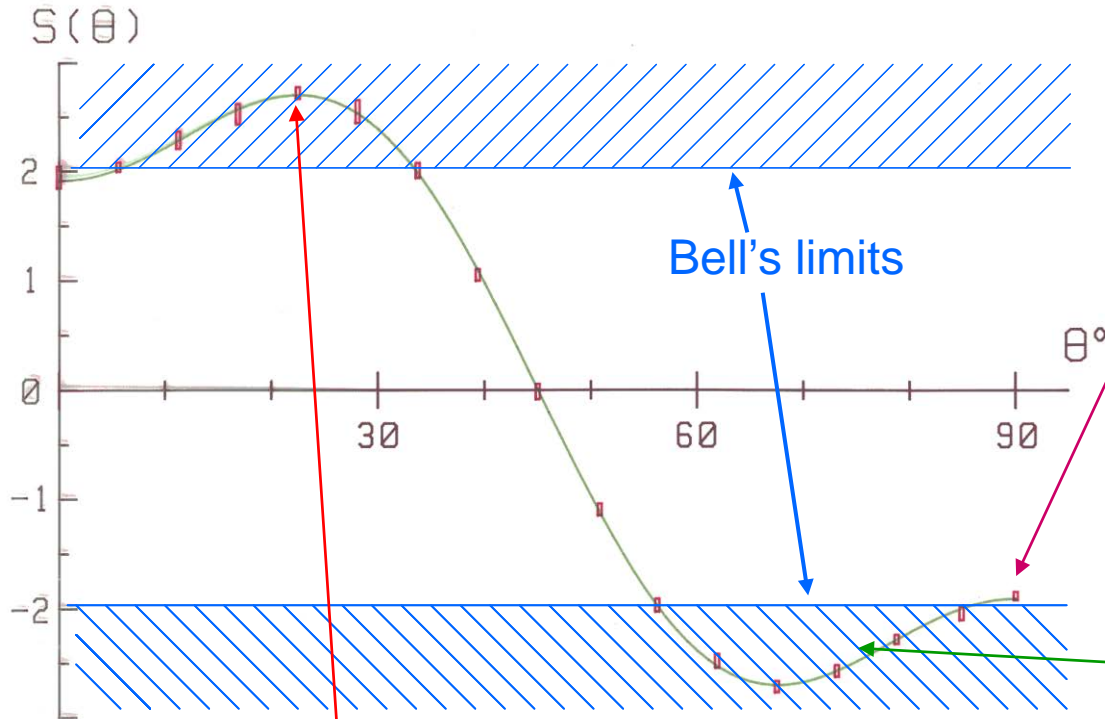

□ Measured value ± 2 standard dev.
— Quantum mechanical prediction (including imperfections of real experiment)

For $\theta = (\mathbf{a}, \mathbf{b}) = (\mathbf{b}, \mathbf{a}') = (\mathbf{a}', \mathbf{b}) = 22.5^\circ$ $S_{\text{exp}}(\theta) = 2.697 \pm 0.015$
 Violation of Bell's inequalities $S \leq 2$ by more than 40σ
 Excellent agreement with quantum predictions $S_{\text{MQ}} = 2.70$

Experiment with variable

polarizers AA, J. Dalibard, G. Roger, PRL 1982

Impose locality as a consequence of relativistic causality: change of polarizer orientations faster than the time of propagation of light between the two polarizers (40 nanoseconds for $L = 12$ m)

☹ Not realist with massive polarizer

☺ Possible with optical switch

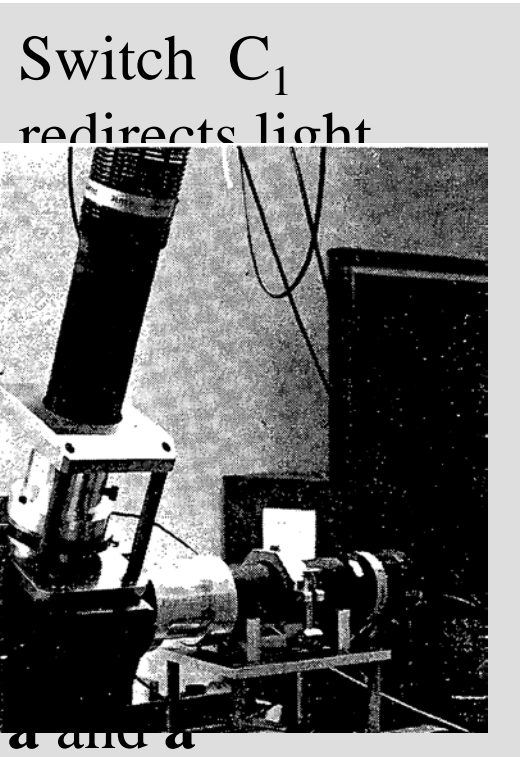
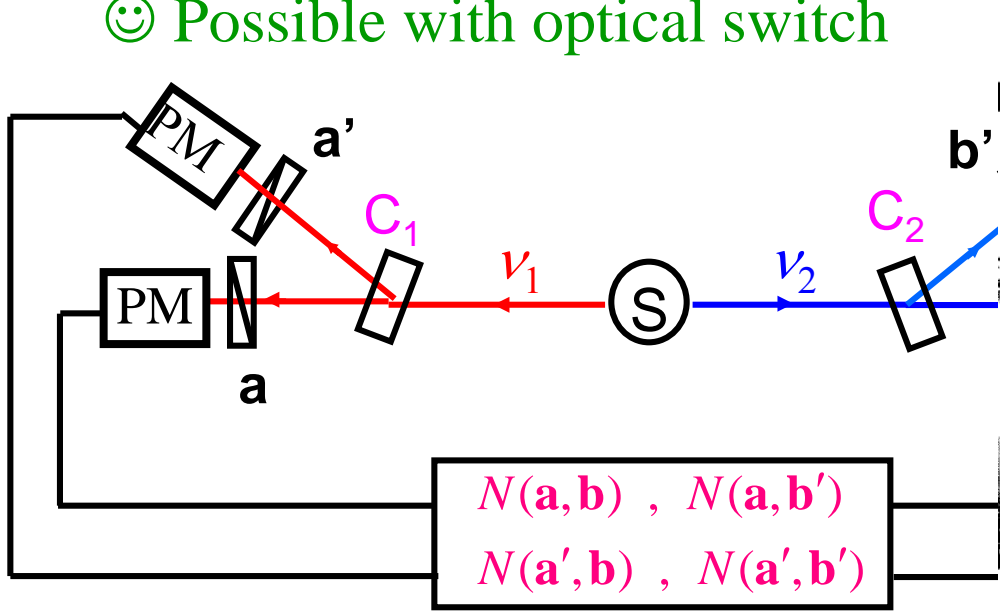

Switch C_1 redirects light

a and a'

Idem C_2 for b and b'

Between two switching: $10 \text{ ns} < L/c \approx 40 \text{ ns}$

Acousto optical switch: change every 10 ns. Faster than propagation of light between polarizers (40 ns) and even than time of flight of photons between the source S and each switch (20 ns).

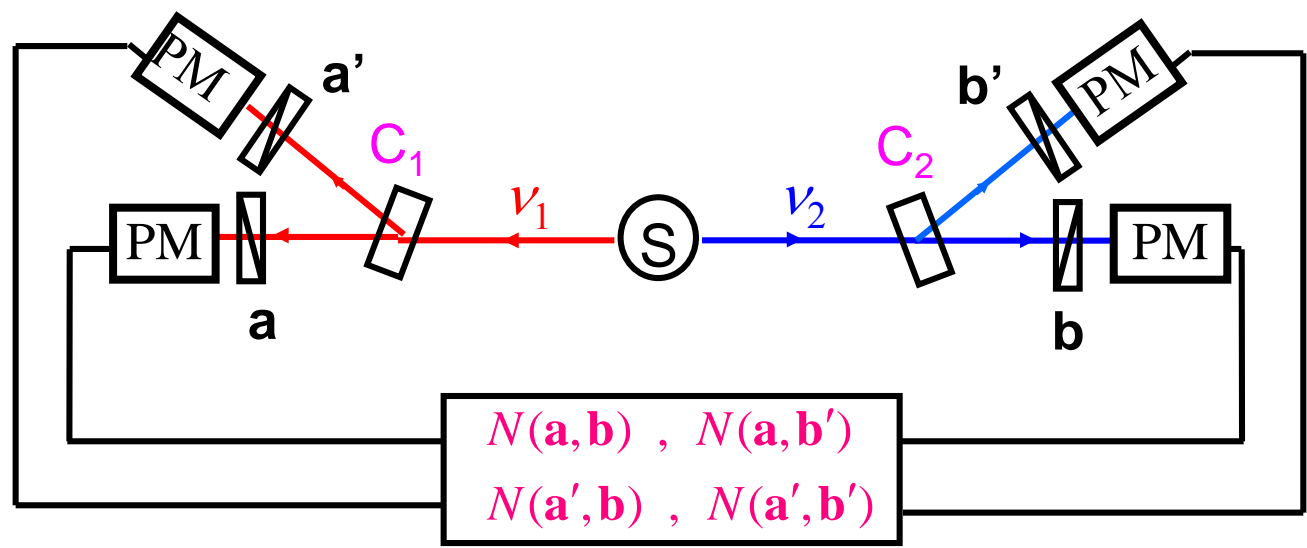

Difficult experiment:
 reduced signal;
 data taking for several hours;
 switching not fully random

Convincing result: Bell's inequalities violated by 6 standard deviations. Each measurement space-like separated from setting of distant polarizer: Einstein's causality enforced

Third generation experiments

Entangled photon pairs by parametric down conversion, well defined directions: injected into optical fibers.

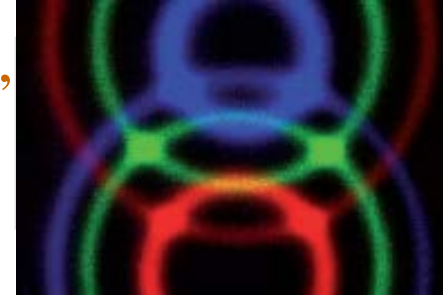

Entanglement at a very large distance

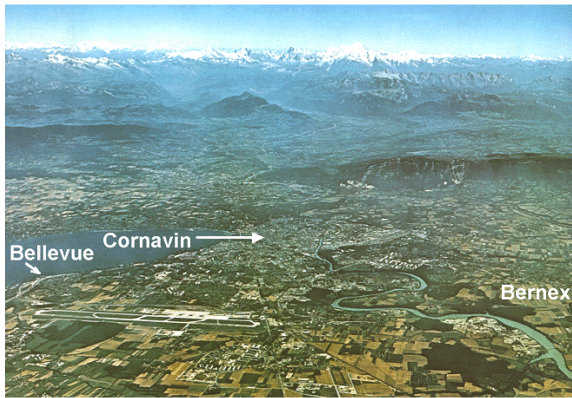

Geneva experiment (1998):

- Optical fibers of the commercial telecom network
- Measurements separated by 30 km

Agreement with QM.

Innsbruck experiment (1998):

variable polarizers with orientation chosen by a random generator during the propagation of photons (several hundreds meters).

Agreement with QM.

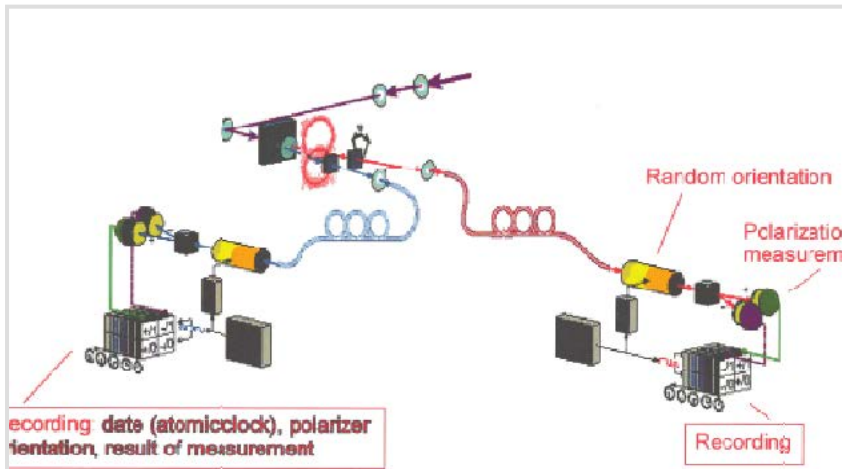

Bell's inequalities have been violated in almost ideal experiments

Results in agreement with quantum mechanics in experiments closer and closer to the GedankenExperiment:

- Sources of entangled photons more and more efficient
- Relativistic separation with variable polarizers (Orsay1982, Innsbruck 1998); closure of “locality loophole”
- High detection efficiencies with trapped ions (Boulder 2000), photons (Vienna, Urbana Champaign 2013): closure of the “sensitivity loophole”
- Both loopholes closed simultaneously (2015): Event ready scheme (Delft); photon pairs (Vienna, Boulder)

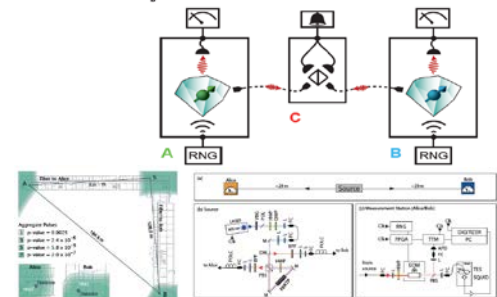
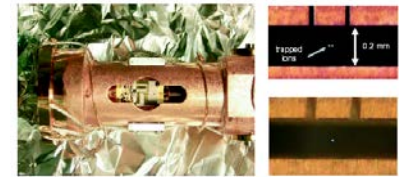
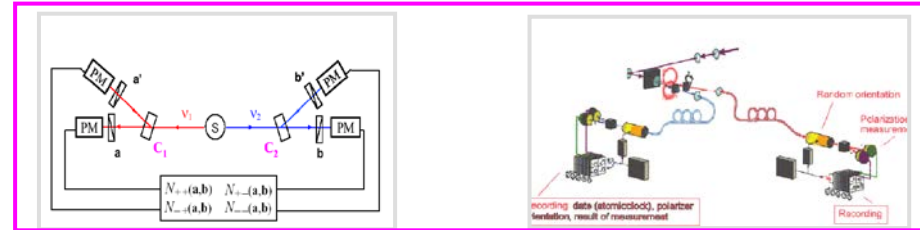
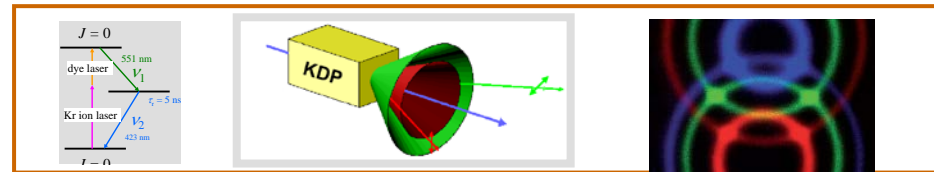

Bell's inequalities have been violated in almost ideal experiments

Results in agreement with quantum mechanics in

ex

Physics

Physics 8, 123 (2015)

Viewpoint

Closing the Door on Einstein and Bohr's Quantum Debate

Alain Aspect

Laboratoire Charles Fabry, Institut d'Optique Graduate School, CNRS, Université Paris-Saclay, Palaiseau, France

Published December 16, 2015

By closing two loopholes at once, three experimental tests of Bell's inequalities remove any doubt that we should renounce local realism. They also open the door to new quantum information technologies.

Subject Areas: Quantum Physics, Optics, Quantum Information

closure of the “sensitivity loophole”

- Both loopholes closed simultaneously (2015): Event ready scheme (Delft); photon pairs (Vienna, Boulder)

Einstein's local realism is untenable

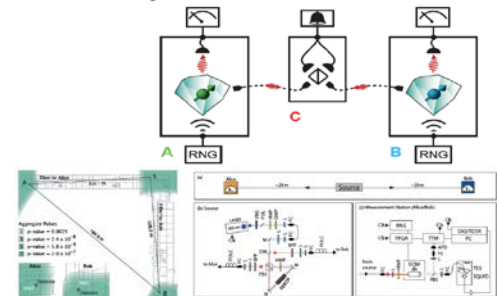

The failure of local realism

Einstein had considered (in order to reject it by *reductio ad absurdum*) the consequences of the failure of the EPR reasoning: [If quantum mechanics could not be completed, one would have to]

- either drop the need of the independence of the physical realities present in different parts of space
- or accept that the measurement of S_1 changes (instantaneously) the real situation of S_2

Quantum non locality – Quantum holism

The properties of a pair of entangled particles are more than the addition of the individual properties of the constituents of the pairs (even space like separated). Entanglement = global property.

NB: no faster than light transmission of a “utilizable” signal (ask!)

From Einstein's doubts to quantum information: a new quantum revolution

1. Quantum technologies: how did they emerge?
2. From the Einstein-Bohr debate to Bell's inequalities tests: entanglement
3. A new quantum revolution: Conceptual and technological

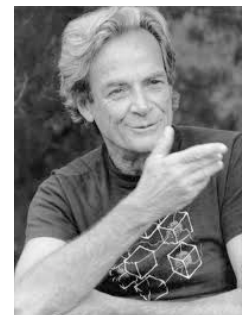
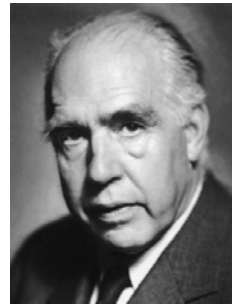

Entanglement: a resource for quantum information

The understanding of the extraordinary properties of entanglement has triggered a new research field: quantum information

Hardware based on different physical principles allows emergence of new concepts in information processing and transport:

- Quantum computing (R. Feynman 1982, D. Deutsch 1985)
- Quantum cryptography (Bennett Brassard 84, Ekert 1991)
- Quantum teleportation (BB&al., 1993; Innsbruck, Roma 1997)
- Quantum simulation (Feynman 1982, Zoller 1998, Bloch 2002)

Entanglement is at the root of most of the schemes for quantum information

Mathematically proven safe cryptography: sharing two identical copies of a secret key

The goal: **distribute** to two partners (**Alice et Bob**) **two identical secret keys** (a random sequence of 1 and 0), with absolute certainty that **no spy (Eve)** has been able to get **a copy of the key**.

Using that key, Alice and Bob can exchange (publicly) a coded message with **a mathematically proven safety** (Shannon theorem) (provided the message is not longer than the key)



Alice

110100101

Eve



110100101



Bob

Quantum optics provides means of safe key distribution

Quantum Key Distribution with entangled photons (Ekert)

Alice and Bob select their analysis directions a et b randomly among 2, make measurements, then send publicly the list of all selected directions

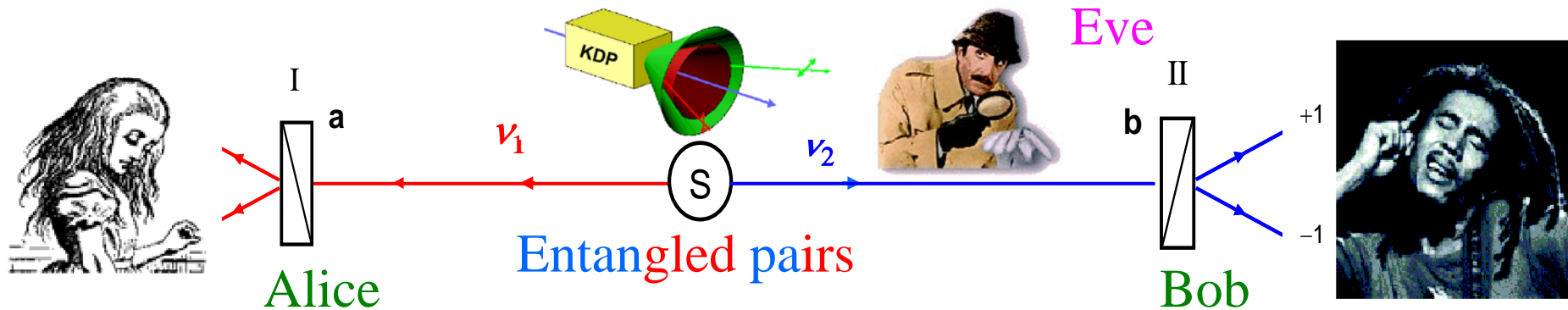

Cases of a et b identical : identical results \Rightarrow 2 identical keys

There is nothing to spy on the entangled flying photons: the key is created at the moment of the measurement.

If Eve chooses a particular direction of analysis, makes a measurement, and reemits a photon according to her result, his maneuver leaves a trace that can be detected by doing a Bell's inequalities test.

QKD at large distance, from space, on the agenda

Quantum computing

A quantum computer could operate new types of algorithms able to make calculations exponentially faster than classical computers.

Example: Shor's algorithm for factorization of numbers: the RSA encryption method would no longer be safe.

Fundamentally different hardware:
fundamentally different software.

What would be a quantum computer?

An ensemble of interconnected quantum gates, processing strings of entangled quantum bits (qubit: 2 level system)

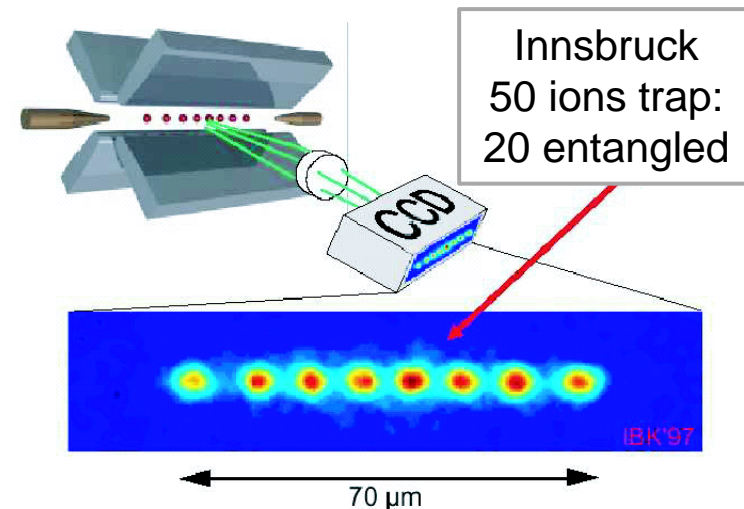

Entanglement \Rightarrow massive parallelism

The Hilbert space to describe N entangled qubits has dimension 2^N !
(most of that space consists of entangled states)

Quantum simulation

Goal: study a system of many entangled particles, absolutely impossible to describe, least to study, on a classical computer (Feynman 1982)

Example: electrons in solids (certain materials still not understood, e.g. high T_C superconductors)

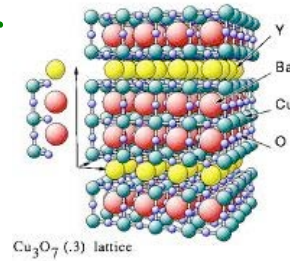

Quantum simulation: mimick the system to study with other quantum particles "easier" to manipulate, observe, with parameters "easy" to modify

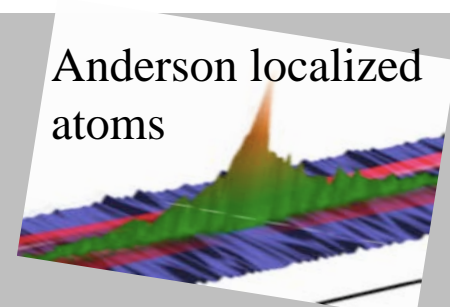

Example: ultracold atoms in synthetic potentials created with laser beams

- Can vary parameters (density, potential...)
- Many observation tools: position or velocity distributions, correlations...

Vortices in atomic superfluid

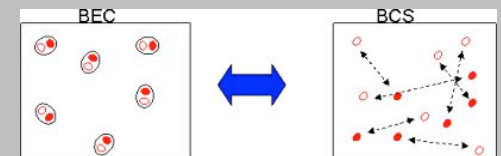
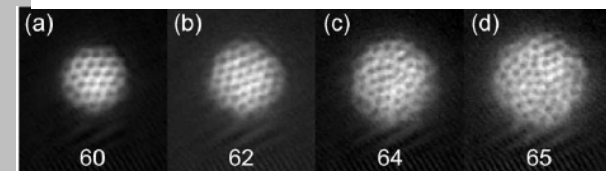

BEC-BCS transition with fermion atoms

Quantum metrology

Exotic quantum states and quantum entanglement allow one to perform measurements beyond the standard limit

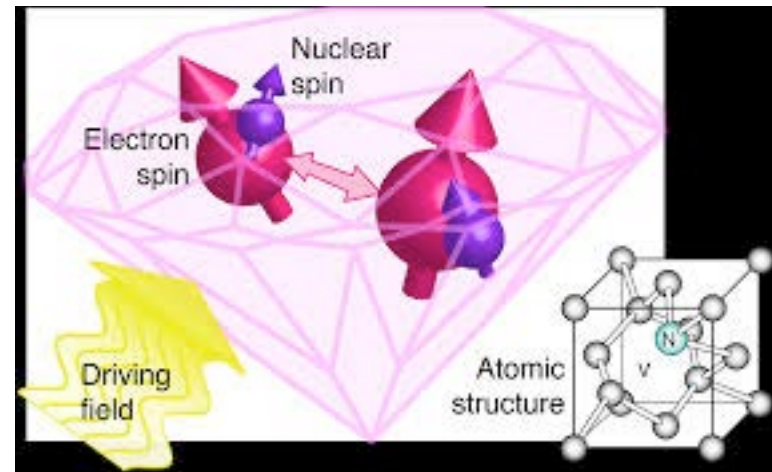
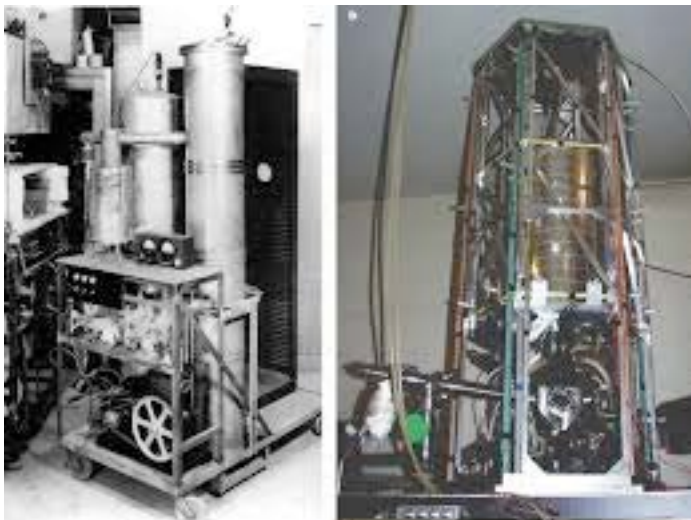

The second quantum revolution

Two concepts at the root of a new quantum revolution

Entanglement

- A revolutionary concept, as guessed by Einstein and Bohr, strikingly demonstrated by Bell, put to use by Feynman et al.
- Drastically different from concepts underlying the first quantum revolution (wave particle duality).

Individual quantum objects

- experimental control
- theoretical description (quantum Monte-Carlo)

Examples: electrons, atoms, ions, single photons, photons pairs

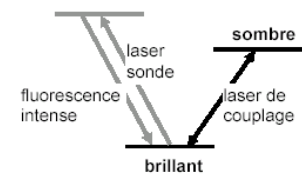
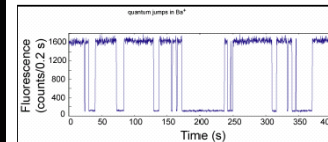
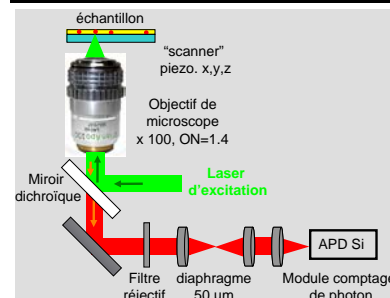
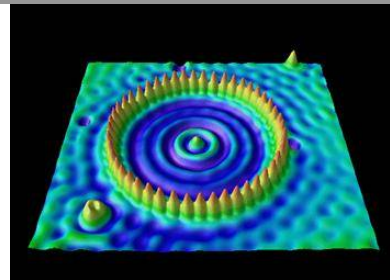

A new quantum era?

Two concepts at the root of a new quantum revolution

Entanglement

- A revolutionary concept, as guessed by Einstein and Bohr, strikingly demonstrated by Bell, put to use by Feynman et al.
- Drastically different from concepts underlying the first quantum revolution (wave particle duality).

Individual quantum objects

- experimental control
- theoretical description (quantum Monte-Carlo)

Examples: electrons, atoms, ions, single photons, photon pairs

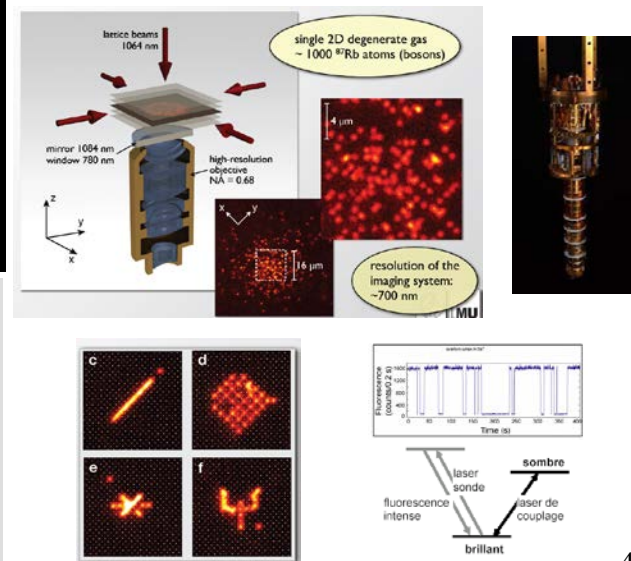
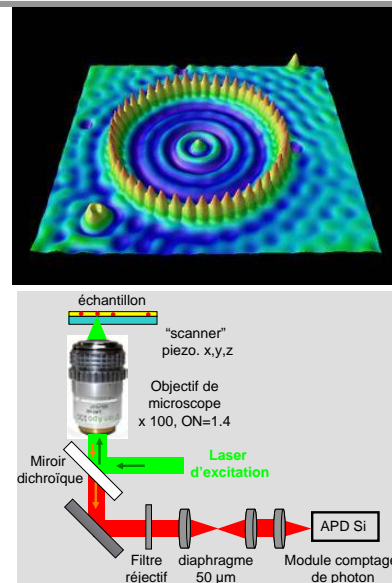

What was the first quantum revolution?

A revolutionary concept: Wave particle duality

- Understanding the structure of matter, its properties, its interaction with light
 - Electrical, mechanical properties
- Understanding “exotic properties”
 - Superfluidity, supraconductivity, Bose Einstein Condensate

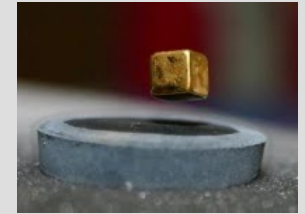
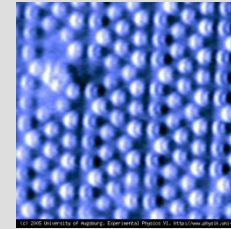

Revolutionary applications

- Inventing new devices
 - Laser, transistor, integrated circuits
- Information and communication society

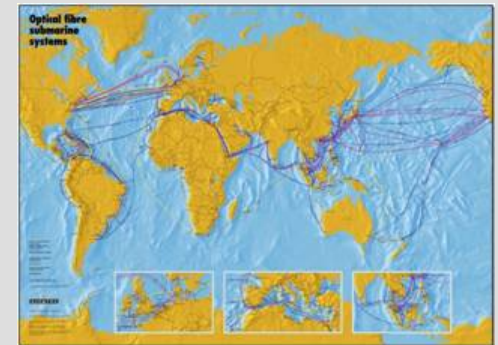
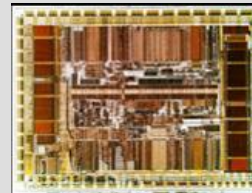
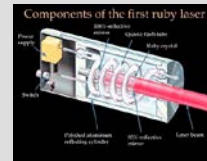

As revolutionary as the invention of heat engine (change society)

Not only conceptual, also technological

Towards a second technological revolution?

Will the new conceptual revolution (entanglement + individual quantum systems) give birth to a new technological revolution?

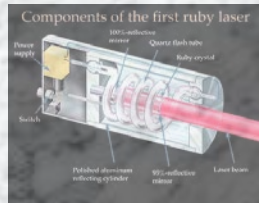

First quantum revolution (wave particle duality): lasers, transistors, integrated circuits \Rightarrow “information society”

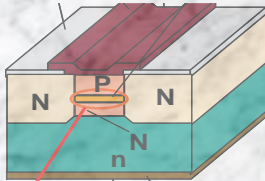
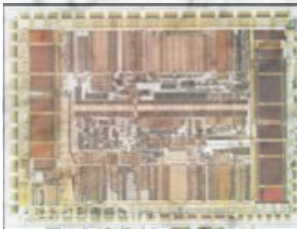

Will quantum information and quantum technologies lead to the “quantum engineering society”?

The most likely roadmap (as usual): from proofs of principle with well defined elementary microscopic objects (photons, atoms, ions, molecules...) to solid state devices (and continuous variables?) ...

A fascinating issue... we live exciting times!

We need the contribution of many people

Thanks
to the
1982
team



Jean Dalibard



Philippe Grangier



Gérard Roger



André Villing

and to the atom optics
group, who makes
quantum simulation
and
quantum atom optics
an experimental
reality



Photo Jean-François Dars

Formation > Moyens pédagogiques (TP,...)

Moyens pédagogiques (TP, ...)

Les **moyens pédagogiques** sont ceux de l'École Supérieure d'Optique et so-
 - des **ressources propres** du service des TP
 - des **ressources du laboratoire** Charles Fabry de l'Institut d'Optique
 - des **ressources des industriels partenaires** (à travers l'ASERFO, l'assoc de soutien à l'enseignement et la formation en optique, ou au travers de dc nature ") et collectivités territoriales (région, département) qui soutienne d'ingénieurs.

Les TP se renouvellent ainsi régulièrement, également grâce à l'**apport par eux-mêmes** lors des projets systèmes de 2ème année et projets de 3ème a

Ce qui suit est un *échantillon* des nombreux TP d'optique et d'électronique s d'enseignement . Vous pouvez pour chaque TP:

- cliquer sur l'imagette pour avoir un agrandi et quelques informations succir
- cliquer sur "télécharger le dossier" , constitué de documents pédagogique les enseignants ou les étudiants : textes, affiches, diaporamas, films, etc.

Contact : [Lionel JACUBOWIEZ](#), responsable du service des TP.



Gyromètre à fibre
 présentation (1,3Mo)



Caméra bolométrique
 poster (1,7Mo)

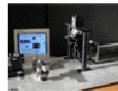

Analyse de fronts d'onde aberrants avec un HASO
 présentation (1,3Mo)



Op



TP de microprocesseur
 article (380Ko)



Transmission numérique sur fibre optique en VHDL
 article (1,5Mo)



Étude de vibromètres laser
 présentation .pdf (2,5Mo)



Bruits



Microscopie



Inégalités de Bell



Effet raman dans une fibre



Transm

Bell's inequalities at the lab classes of the Institut d'Optique Graduate School



École Supérieure d'Optique
 Moyens au service
 des travaux-pratiques Inst

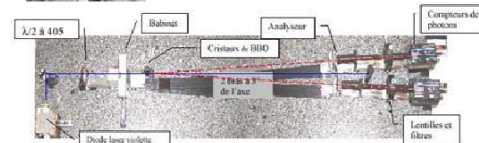

Matériel - mots cle
 Diode laser - cristaux linéaires – photons intrin analyseurs de polarisat détection de photon uni comptage de photor corrélateur électronique

INEGALITES DE BELL :

Expérience EPR - mécanique quantique – photons intriqués en polarisation – variables cachées – corrélations de détection de « phot uniques »

Appendix

No faster than light signaling with
EPR pairs

No faster than light signaling with EPR entangled pairs

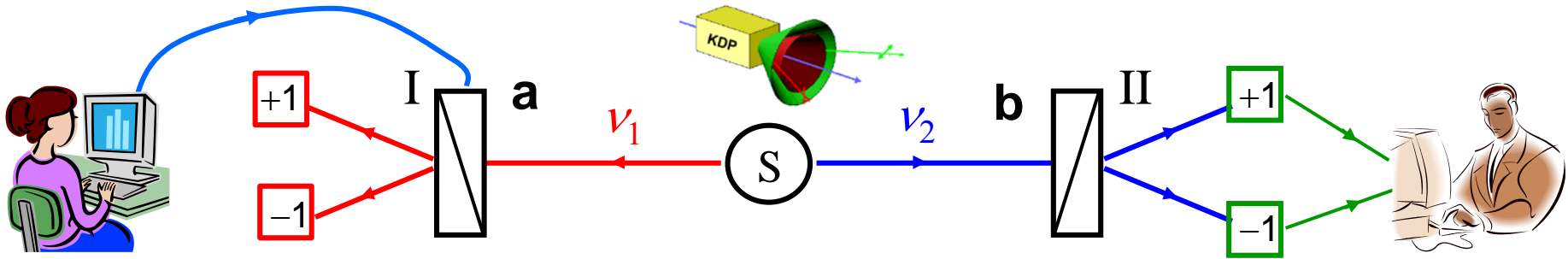

Alice changes the setting of polarizer I from a to a' : can Bob **instantaneously** observe a change on its measurements at II ?

Single detections: $P_+(\mathbf{b}) = P_-(\mathbf{b}) = 1/2$ No information about a

Joint detections: $P_{++}(\mathbf{a}, \mathbf{b}) = P_{--}(\mathbf{a}, \mathbf{b}) = \frac{1}{2} \cos^2(\mathbf{a}, \mathbf{b})$ etc.

Instantaneous change !

Faster than light signaling ?

No faster than light signaling with EPR entangled pairs

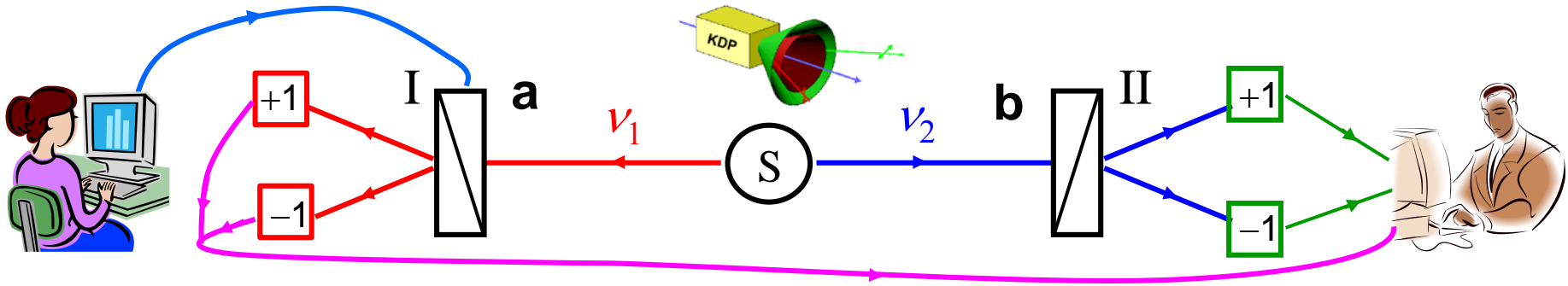

Alice changes the setting of polarizer I from \mathbf{a} to \mathbf{a}' : can Bob **instantaneously** observe a change on its measurements at II ?

Joint detections: $P_{++}(\mathbf{a}, \mathbf{b}) = P_{--}(\mathbf{a}, \mathbf{b}) = \frac{1}{2} \cos^2(\mathbf{a}, \mathbf{b})$ etc.

Instantaneous change ! Faster than light signaling ?

To measure $P_{++}(\mathbf{a}, \mathbf{b})$ Bob must compare his results to the results at I: the **transmission** of these results from I to Bob is done on a **classical channel, not faster than light.**

cf. role of classical channel in quantum teleportation.

So there is no problem ?

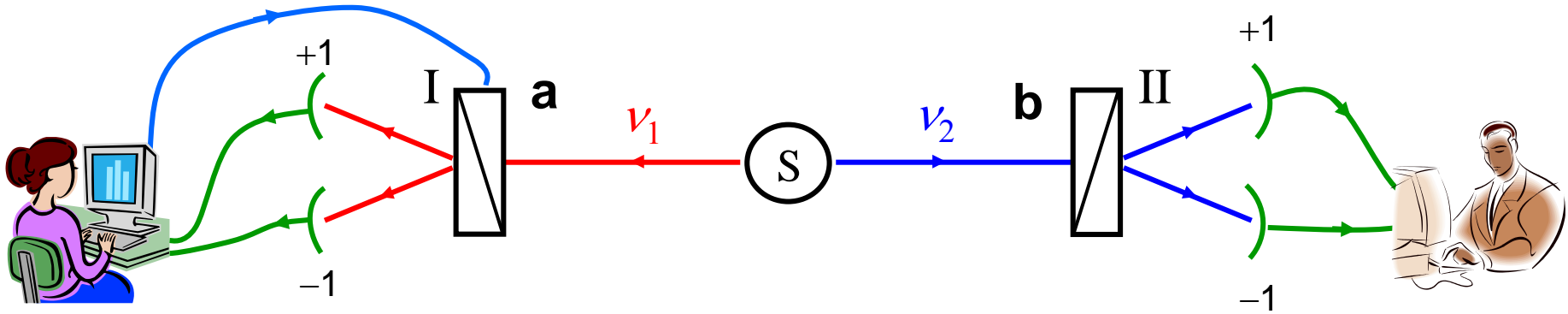

View *a posteriori* onto the experiment:

During the runs, Alice and Bob carefully record the time and result of each measurement.

After completion of the experiment, they meet and compare their data...

... and they find that $P_{++}(\mathbf{a}, \mathbf{b})$ had changed instantaneously when Arthur had changed his polarizers orientation...

Non locality still there, but cannot be used for « practical telegraphy »

Is it a real problem ?

« It has not yet become obvious to me that there is no real problem. I cannot define the real problem, therefore I suspect there's no real problem, but I am not sure there is no real problem. So that's why I like to investigate things. »*

R. Feynman: *Simulating Physics with Computers*, Int. Journ. of Theoret. Phys. 21, 467 (1982)**

* This sentence was written about EPR correlations

** A founding paper on quantum computers

It took a long time for entanglement to be recognized as a revolutionary concept

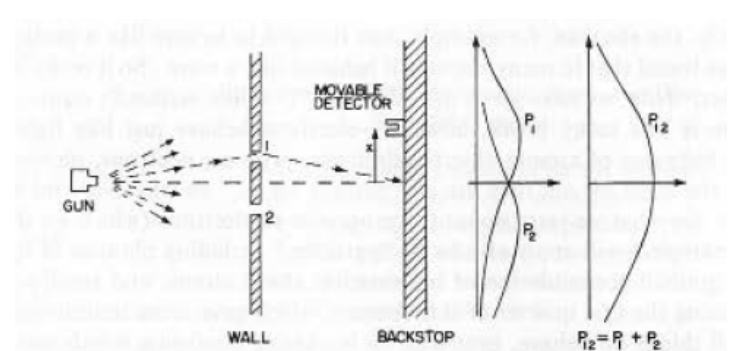
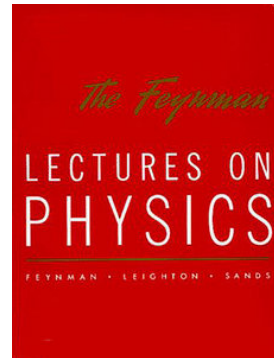
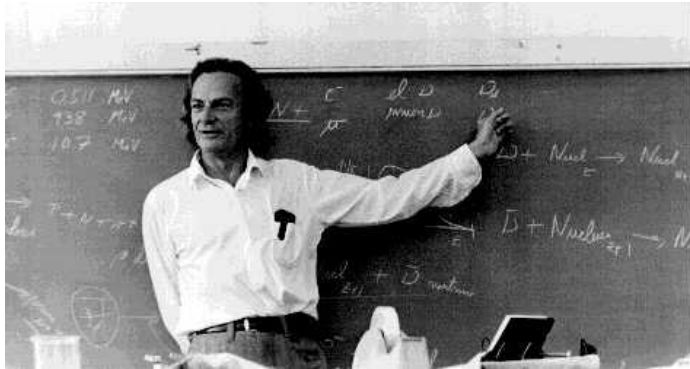

Wave particle duality for a single particle: the only mystery (1960)

*In this chapter we shall tackle immediately the basic element of the mysterious behavior in its most strange form. We choose to examine a phenomenon which is impossible, absolutely impossible, to explain in any classical way, and which has in it the heart of quantum mechanics. **In reality it contains the only mystery.***

Entanglement thought not to be different in nature (1960)

This point was never accepted by Einstein... It became known as the Einstein-Podolsky-Rosen paradox. But when the situation is described as we have done it here, there doesn't seem to be any paradox at all...

It took a long time for entanglement to be recognized as a revolutionary concept

we always have had (secret, secret, close the doors!) we always have had a great deal of difficulty in understanding the world view that quantum mechanics represents. At least I do

Simulating Physics with Computers

Richard P. Feynman 1982

I've entertained myself always by squeezing the difficulty of quantum mechanics into a smaller and smaller place, so as to get more and more worried about this particular item.

It seems to be almost ridiculous that you can squeeze it to a numerical question that one thing is bigger than another. But

there you are-it is bigger than any logical argument can produce

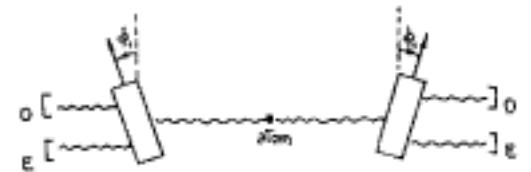

Entanglement recognized as another mystery, and...

Entanglement: a resource for quantum information

The understanding of the extraordinary properties of entanglement has triggered a new research field: quantum information

Hardware based on different physical principles allows emergence of new concepts in information processing and transport:

- Quantum computing (R. Feynman 1982, D. Deutsch 1985)
- Quantum cryptography (Bennett Brassard 84, Ekert 1991)
- Quantum teleportation (BB&al., 1993; Innsbruck, Roma 1997)
- Quantum simulation (Feynman 1982, Zoller 1998, Bloch 2002)

Entanglement is at the root of most of the schemes for quantum information